

# Multi-Zone ART Workstation

**ESCO**  
MEDICAL



# Multi-Zone ART Workstation



*Multi-Zone ART Workstation –  
Supports superior and gentle handling of your embryos.*

# FEATURES:

## Touchscreen Monitor

The touchscreen monitor is a fully functional Windows PC with additional features:

- Displays the temperature of the heated surface, as well as the gas flow and pressure. Reports of these parameters can be generated.
- Allows the user to observe and record culture behavior via the microscope's camera function in real-time.
- Enables teleconference calls\* with colleagues in other locations for real-time collaborative work.

\*Webcam is not supplied.

## Multi-Zone Heating System with Four (4) Temperature Modes

1 setpoint, up to 12 independent zones per working area with their own heating elements and sensors allow excellent uniformity. The heating system will automatically prioritize power distribution to ensure effective temperature control with fast recovery. In models that feature MIRI® chambers, temperature regulation of the chambers will always be on regardless of mode.

• Accuracy:  $\pm 0.2\text{ }^{\circ}\text{C}$

• Uniformity:  $\pm 0.2\text{ }^{\circ}\text{C}$

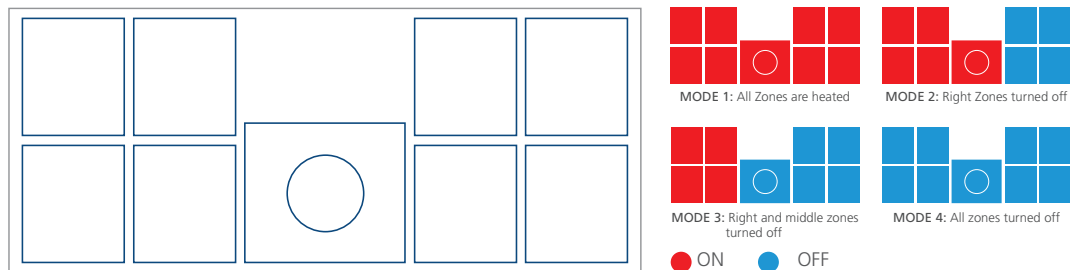

\*The provided example of heating zone overlay is applicable for MAW-4D\_model. For different heating zone layouts, please read pages 6 to 10 and pages 13 to 16. The heating modes are the same for all the models



## Humidification System

The Multi-zone ART Workstation design does not allow active control of humidity levels in circulated gas. The humidification method used in the Multi-zone ART Workstation increases circulating gas' humidity, which will decrease evaporation risks in media of Petri dishes placed in the chambers. On models without MIRI® chambers semi-closed environment can be created with a plastic cover.

## Stainless-Steel Table-top

The main material used in the table-top surface is stainless-steel, which ensures its strength and rigidity.



## Microscope Integration Provision

The integrated stereoscope in the work chamber allows users to maintain culture dishes at steady temperature during observation and manipulation. Fewer movements will also reduce risk of accidents.



## Heated Glass Stage

The heated glass stage has its own independent heating zone further to enhance the temperature control and recovery in this zone.



## Surveillance System\*\*

Provides the user with real-time information of zone performance and other work area parameters such as gas pressure and flow rate.

\*\*When any of the heating zones are OFF, the monitor shall not display real-time temperature as there are no controlled heating to give uniformity across the OFF zone.



# Advanced Workstation specifically designed for **Assisted Reproductive Technology (ART)** such as gamete and embryo manipulation during IVF.

High-tech components and features are designed in Denmark and made in Esco's production facilities in Europe.

The workstation keeps true to Esco's world class expertise and quality in cleanroom technology.

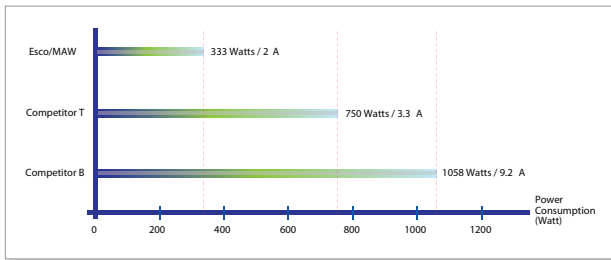

## Energy Efficient Chart

Multi-Zone ART Workstations are equipped with top-of-the-line ECM blowers that allow the cabinet to have low power consumption without sacrificing the cabinet's performance.

- **Standby mode** (very low power usage) is also available when the workstation is not in use.

Air Cleanliness Standards (ISO 14644.1, Air Cleanliness Particle Limits) (No. of Particles / m <sup>3</sup> )						
Particle Size (µm)	Cleanliness Class					
	Class 1	Class 2	Class 3	Class 4	Class 5	Class 6
0.1	10	100	1000	10000	100000	1000000
0.2	2	24	237	2370	23700	237000
0.3	1	10	102	1020	10200	102000
0.5	-	4	35	352	3520	35200
1.0	-	-	8	83	832	8320
5.0	-	-	-	3	29	293

## Superior Air Cleanliness

Esco cabinets, complying with ISO 14644-1 standard, are able to provide significantly better ISO Class 3 air cleanliness within the work zone than other competitors.

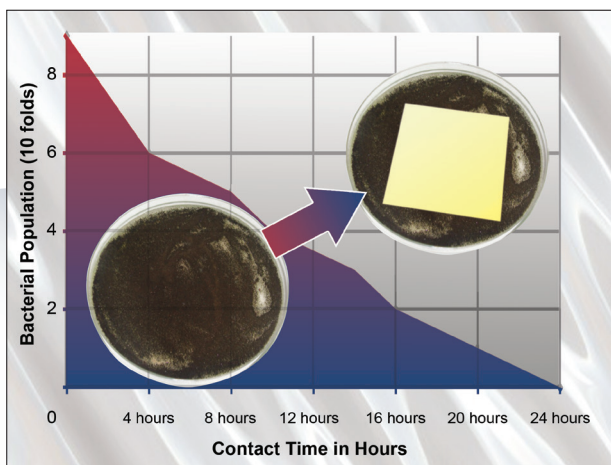

## Isocide™ Powder Coat

All Multi-Zone ART Workstations are coated with a silver-ion-impregnated powder that improves the safety of the workstation by inhibiting the growth of microbes.

# Multi-Zone ART Workstation

- Sample protection by vertical laminar airflow.
- Possibility to install most common microscopes.
- Heated glass stage and SC-1 LED Light source with a dual-sided mirror and intensity control knob integrated.
- A couple of support stand types are available: support stand with leveling feet/caster wheels or telescopic support stand with caster wheels.
- Ability to choose between 3ft (single without MIRI® chambers), 4ft (single with/without MIRI® chambers) and 6ft (single, dual, MP and with/without MIRI® chambers) models.



## Less Noise, Less Vibration

State-of-the-art design of the Multi-Zone ART Workstation results in very low noise and vibration level production, which makes this workstation suitable for delicate microscopic work. This is achieved by integrating

- Two (2) smaller high-efficiency ECM blowers that create less noise and vibrations than 1 big blower fan.
- Passive dampers along the connection of the table plate to the cabinet which effectively dampens any vibrations.



## Cable Pass-Through Tunnels

The Multi-Zone ART workstation has a convenient way for electrical cables of other equipment and/or accessories (i.e., a camera) to pass through its back wall. This provides a cleaner and more organized interior that should help improve your IVF workflow.

Cable Pass-Through Tunnel

Cable Wire



# Multi-Zone ART Workstation (Single Microscope)

MAW-3D\_

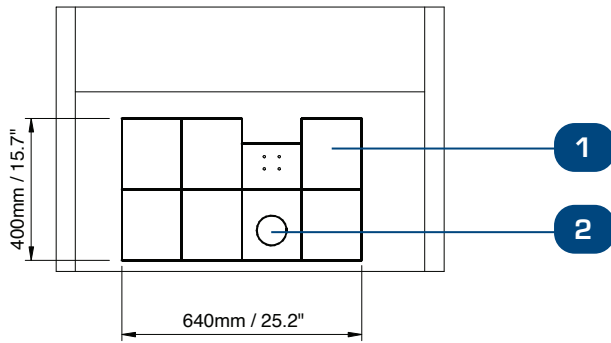

- Width: 3 Feet
- Microscope: Single
- Basic Configuration
- Accomodates 1 user
- Ideal for small laboratories

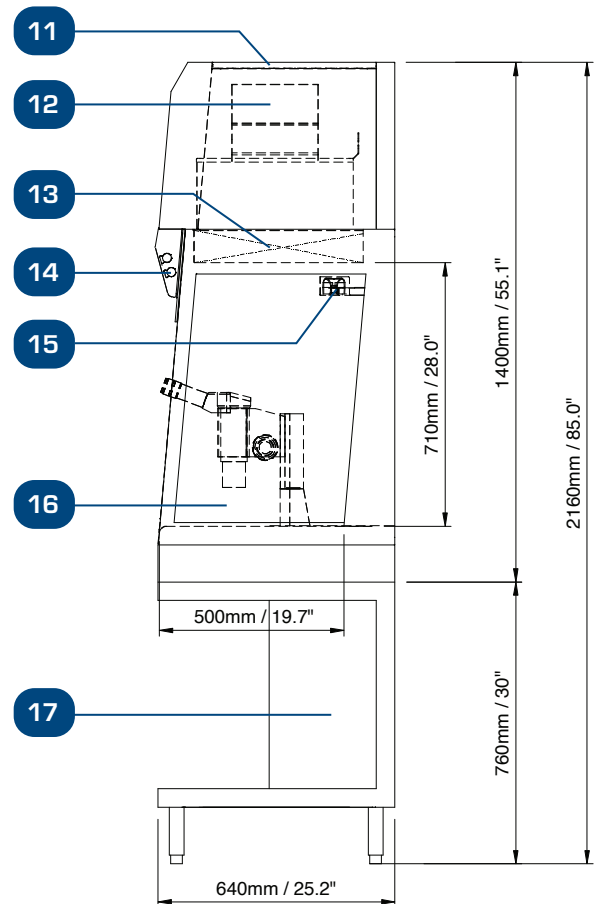
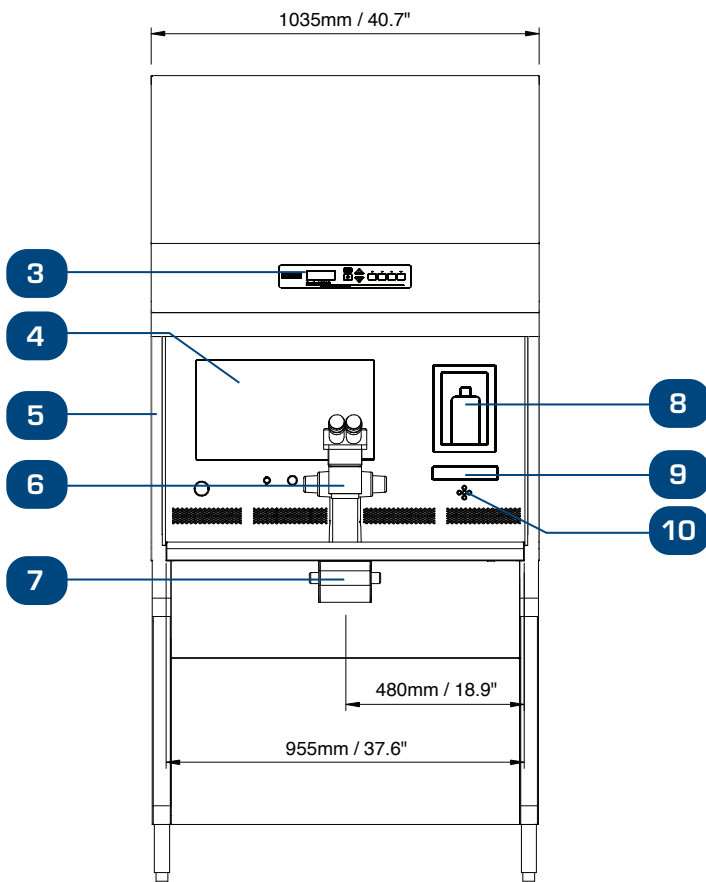

1. Multi-Zone Heated Table Top (7+1 Zones)
2. Integrated Heated Glass Stage
3. Esco Sentinel™ Gold Microprocessor Control System
4. Side Tempered Glass
5. Touchscreen Monitor (AIO PC)
6. Provision for Microscope (Microscope not Included)
7. Integrated Light Source, SC-1
8. Humidification System with Digital Flow Control of Pre-mixed Gas

9. LED Display
10. Control Panel for Heated Table Top and Humidification System
11. Pre-Filter
12. Blower
13. ULPA Filter
14. Fluorescent Light
15. Airflow Sensor
16. Side Tempered Glass
17. Support Stand (Model: SML-3B0)

# MAW-4D\_

- Width: 4 Feet
- Microscope: Single
- Basic Configuration
- Accomodates 1 user
- Ideal for small laboratories

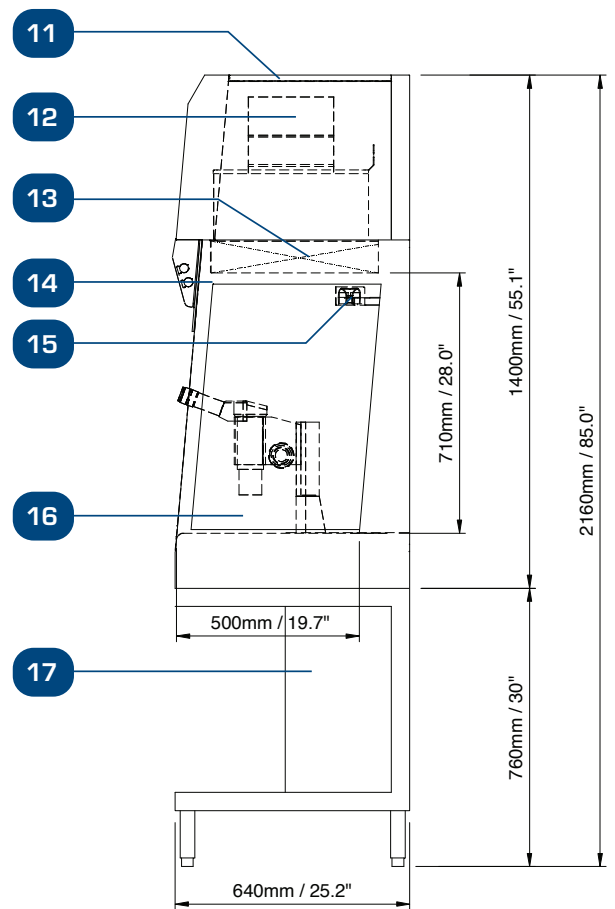
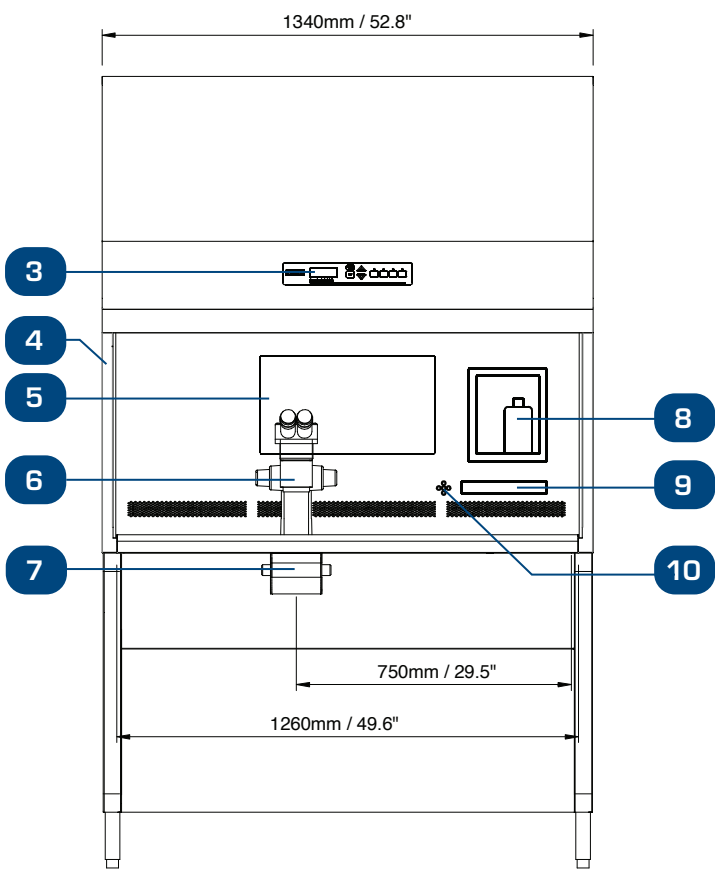
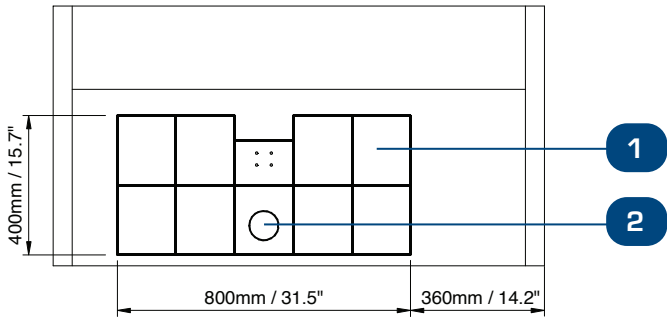

1. Multi-Zone Heated Table Top (9+1 Zones)
2. Integrated Heated Glass Stage
3. Esco Sentinel™ Gold Microprocessor Control System
4. Side Tempered Glass
5. Touchscreen Monitor (AIO PC)
6. Provision for Microscope (Microscope not Included)
7. Integrated Light Source, SC-1
8. Humidification System with Digital Flow Control of Pre-mixed Gas

9. LED Display
10. Control Panel for Heated Table Top and Humidification System
11. Pre-Filter
12. Blower
13. ULPA Filter
14. Fluorescent Light
15. Airflow Sensor
16. Side Tempered Glass
17. Support Stand (Model: SML-4B0)

# Multi-Zone ART Workstation (Single Microscope)

## MAW-6D\_MONO

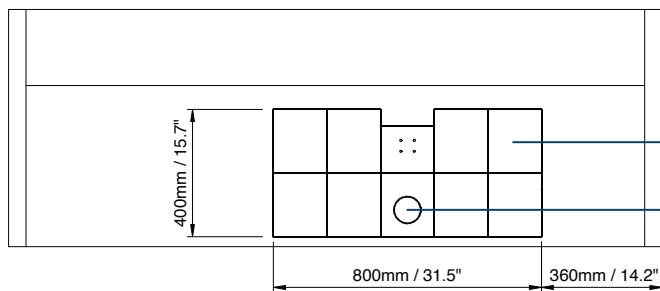

- Width: 6 Feet
- Microscope: Single
- Basic Configuration
- Accomodates 1 user
- Ideal for small laboratories

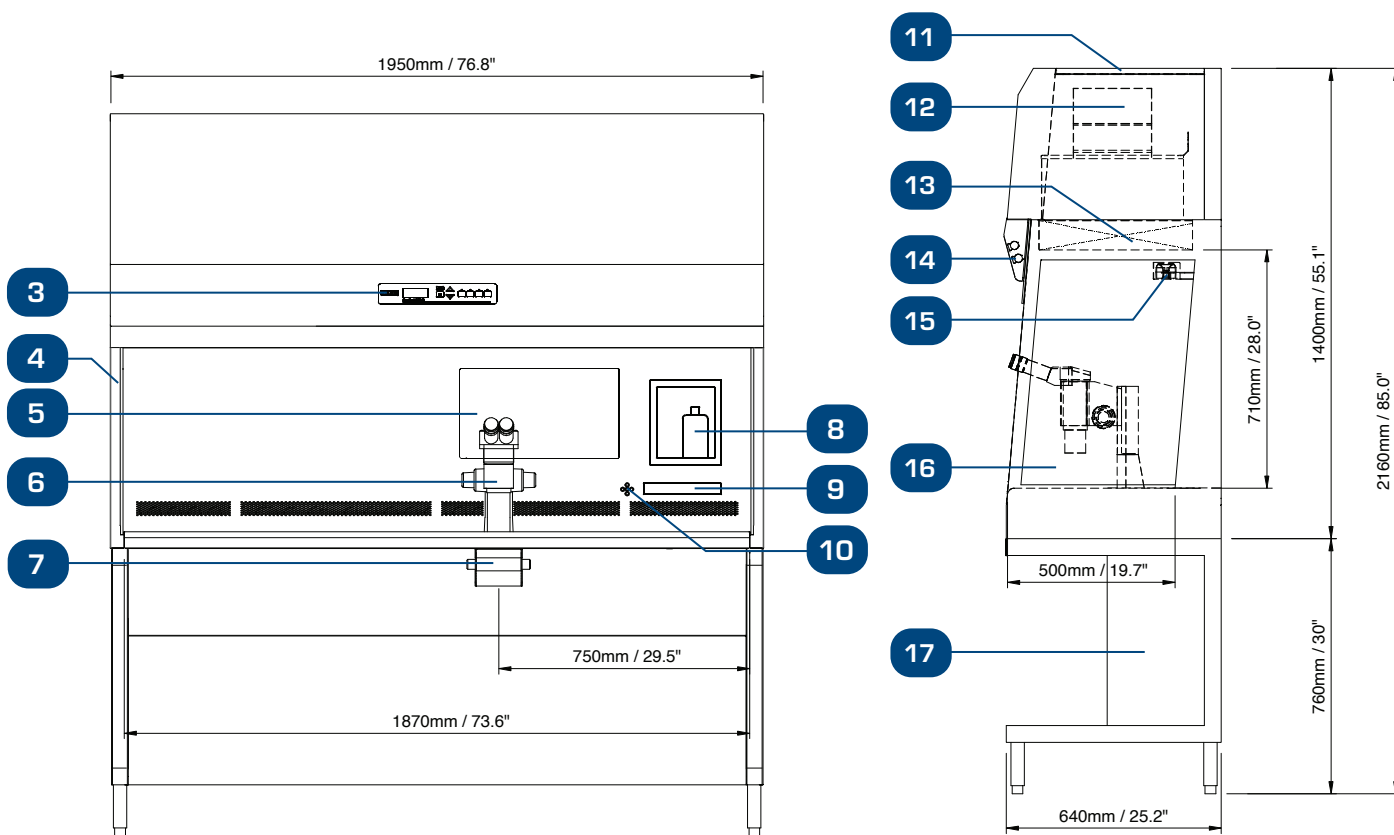

1. Multi-Zone Heated Table Top (9+1 Zones)
2. Integrated Heated Glass Stage
3. Esco Sentinel™ Gold Microprocessor Control System
4. Side Tempered Glass
5. Touchscreen Monitor (AIO PC)
6. Provision for Microscope (Microscope not Included)
7. Integrated Light Source, SC-1
8. Humidification System with Digital Flow Control of Pre-mixed Gas
9. LED Display
10. Control Panel for Heated Table Top and Humidification System
11. Pre-Filter
12. Blower
13. ULPA Filter
14. Fluorescent Light
15. Airflow Sensor
16. Side Tempered Glass
17. Support Stand (Model: SML-6B0)



# Multi-Zone ART Workstation (Dual Microscope)

## MAW-6D\_-DUAL

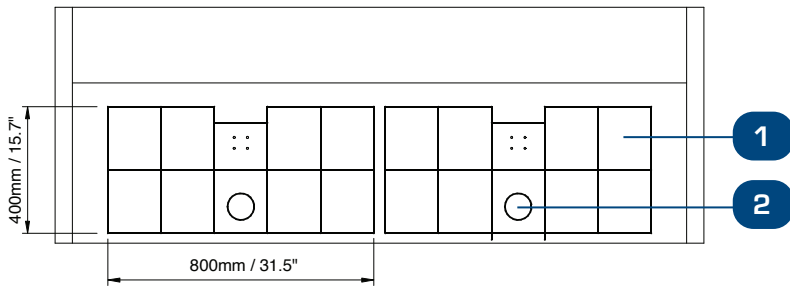

- Width: 6 Feet
- Microscope: Dual
- Accomodates 2 users
- For those who want to use all available area of the workspace

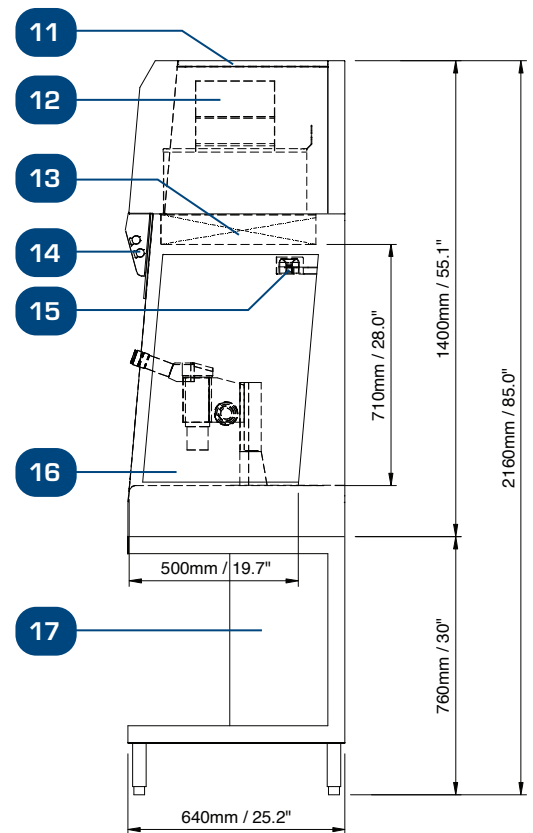
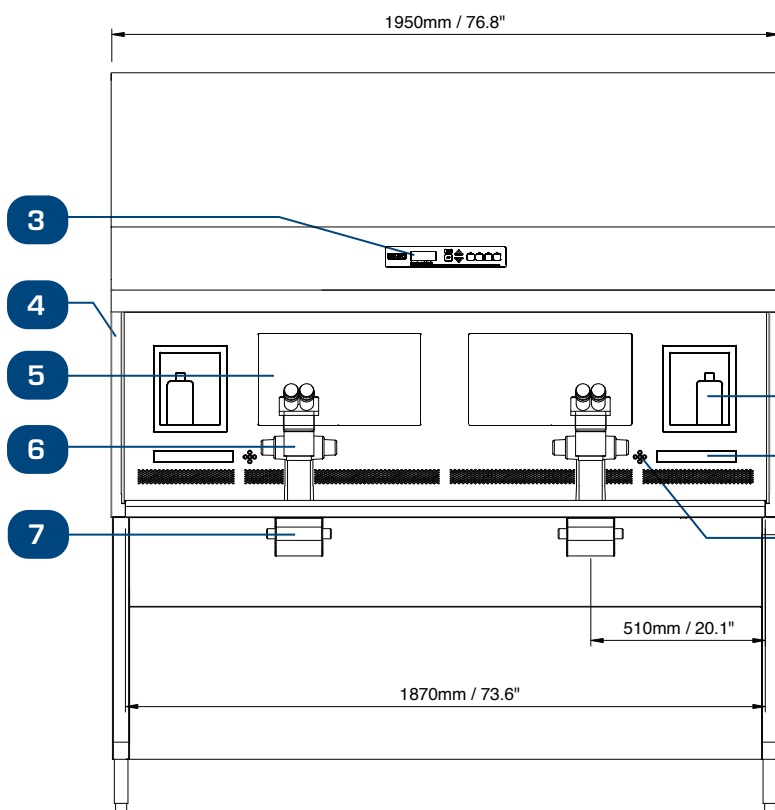

- |   |  |
|---|--|
| 1. Multi-Zone Heated Table Top (18+2 Zones)                         | 9. LED Display   |
| 2. Integrated Heated Glass Stage                                    | 10. Control Panel for Heated Table Top and Humidification System |
| 3. Esco Sentinel™ Gold Microprocessor Control System                | 11. Pre-Filter   |
| 4. Side Tempered Glass  | 12. Blower   |
| 5. Touchscreen Monitor (AIO PC)                                     | 13. ULPA Filter  |
| 6. Provision for Microscope (Microscope not Included)               | 14. Fluorescent Light  |
| 7. Integrated Light Source, SC-1                                    | 15. Airflow Sensor   |
| 8. Humidification System with Digital Flow Control of Pre-mixed Gas | 16. Side Tempered Glass  |
|   | 17. Support Stand (Model: SML-6B0)                               |

# Multi-Zone ART Workstation (Multi-Purpose)

MAW-6D\_-MP

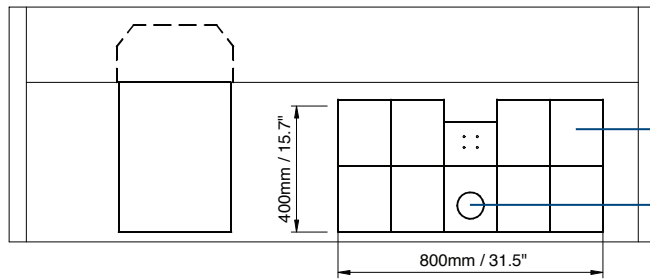

- Width: 6 Feet
- Microscope: 1 stereomicroscope with the ability to integrate 1 inverted microscope
- Accommodates 2 users
- Multi-purpose – ideal for embryo inspection and micro manipulation

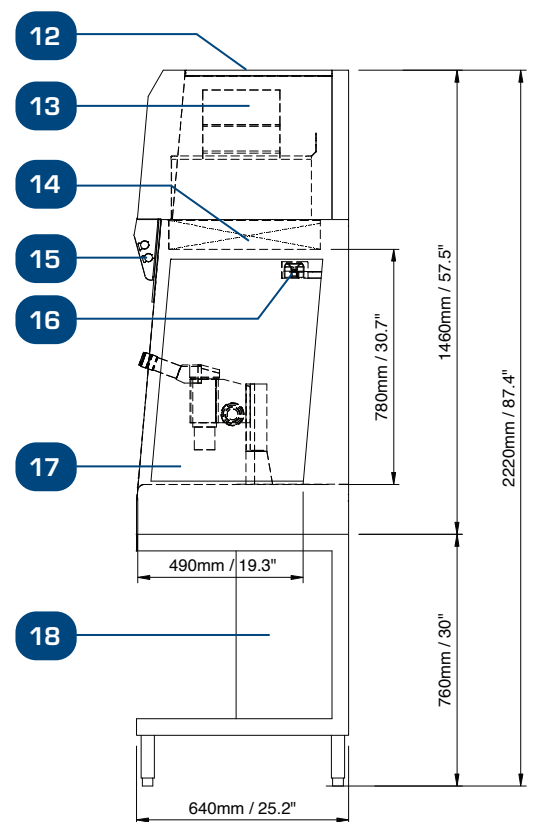
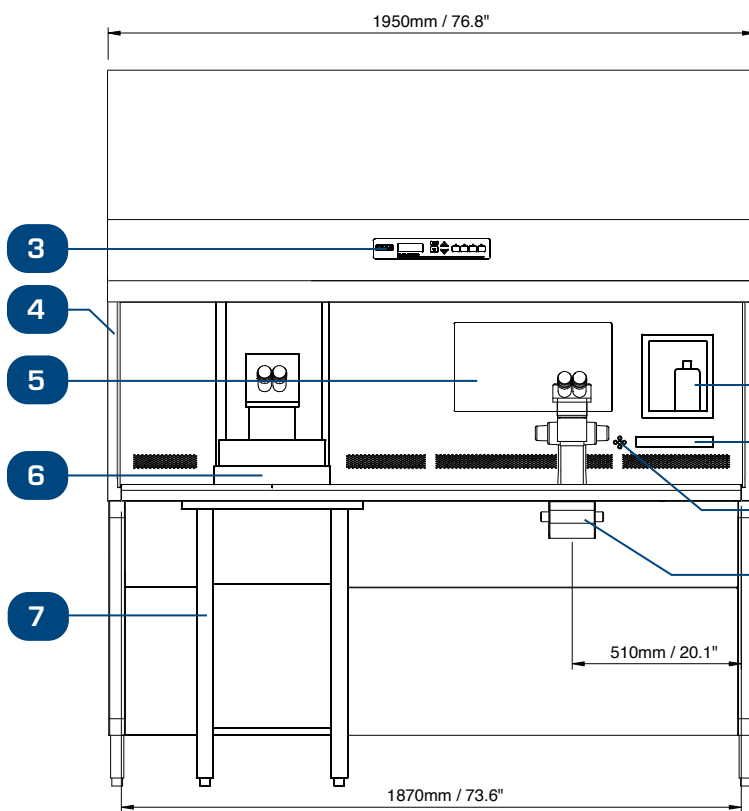

- |   |  |
|---|--|
| 1. Multi-Zone Heated Table Top (9+1 Zones)                          | 9. LED Display   |
| 2. Integrated Heated Glass Stage                                    | 10. Control Panel for Heated Table Top and Humidification System |
| 3. Esco Sentinel™ Gold Microprocessor Control System                | 11. Integrated Light Source, SC-1                                |
| 4. Side Tempered Glass  | 12. Pre-Filter   |
| 5. Touchscreen Monitor (AIO PC)                                     | 13. Blower   |
| 6. Provision for Microscope (Microscope not Included)               | 14. ULPA Filter  |
| 7. Anti-Vibration Table (AVT)                                       | 15. Fluorescent Light  |
| 8. Humidification System with Digital Flow Control of Pre-mixed Gas | 16. Airflow Sensor   |
|   | 17. Side Tempered Glass  |
|   | 18. Support Stand (Model: SML-6B0)                               |

# General Specifications

## Multi-Zone ART Workstation (MAW)

Model	MAW-3D_	MAW-4D_	MAW-6D_-MONO	MAW-6D_-DUAL	MAW-6D_-MP
Nominal Size	0.9 meter (3')	1.2 meter (4')	1.8 meter (6')		
Internal Work area dimensions (W x D x H)*	955 x 500 x 710 mm (37.6" x 19.7" x 28.0")	1260 x 500 x 710 mm (49.6" x 19.7" x 28.0")	1870 x 500 x 710 mm (73.6" x 19.7" x 28.0")		1870 x 490 x 780 mm (73.6" x 19.3" x 30.7")
External dimensions w/o support stand (W x D x H)	1035 x 640 x 1400 mm (40.7" x 25.2" x 55.1")	1340 x 640 x 1400 mm (52.8" x 25.2" x 55.1")	1950 x 640 x 1400 mm (76.8" x 25.2" x 55.1")		1950 x 647 x 1460 mm (76.8" x 25.4" x 57.5")
External Dimensions with "B" type support stand (W x D x H)	1035 x 640 x 2160 mm (40.7" x 25.2" x 85")	1340 x 640 x 2160 mm (52.8" x 25.2" x 85.0")	1950 x 640 x 2160 mm (76.8" x 25.2" x 85.0")		1950 x 647 x 2220 mm (76.8" x 25.4" x 87.4")
Cabinet Construction	Main Body	1.2 mm (0.05") 18-gauge electro-galvanized steel with white oven-baked epoxy-polyester powder coated finish			
	Work Zone	1.5 mm (0.6") gauge 16 stainless steel, grade 304	1.2 mm (0.05") 18 gauge stainless steel, grade 304		
	Side Walls	Tempered Glass (Optional: Polycarbonate sash for MAW with built-in UV light)			
	Sash				
Laminar Air Velocity	Average of 0.21m/s or 41 fpm (± 20%)				
Filter Efficiency	>99.999% for particle size between 0.1 to 0.3 microns per IEST-RP-CC001.3 / H14 per EN 1822				
Pre-filter	Disposable and non-washable polyester fibers with 85% arrestance / EU3 rated				
Noise level (per NSF 49)**	47 dBA	47 dBA	52 dBA		
Set of (9+1) Heating Zones	(7+1) Heating Zone	1 set	1 set	2 sets	1 set
Surveillance System with data logger	1 set	1 set	1 set	2 sets	1 set
Humidification System***	1 set	1 set	1 set	2 sets	1 set
PT 1000 ports	5 ports	5 ports	5 ports	10 ports	5 ports
Microscope	Required, Not included (see microscope ordering information)				
	Position for 1 microscope			Position for 2 stereo microscopes	Position for 1 microscope and 1 inverted microscope
Transmitted Light Source	1 set	1 set	1 set	2 sets	1 set
Support Stand	Required, Not included (see support stand ordering information)				
Shipping Dimensions (width x depth x height)	1120 X 820 X 1920 mm (44.1" x 32.3" x 75.6")	1450 x 850 x 1920 mm (57.1" x 33.5" x 75.6")	2050 x 850 x 1890 mm (80.8" x 33.5" x 74.4")		
Shipping weight	195 kg	280 kg	372 kg		
Operating altitude	Up to 2000 meters (6560 feet or 89kPa – 106kPa)				

\* The actual MAW-6D-MP's working area dimensions will be customized to fit the inverted microscope.

\*\* Noise reading in open field condition / anechoic chamber: Noise reading in a normal room varies by room size, layout, and background noise, but may reach roughly 3-4 dBA above these values.

\*\*\* 1 set of humidification system includes one (1) water bottle with tubing, one (1) sample carry tray and one (1) plastic cover.

## Indication for Use Statement

The Multi-zone ART Workstation is a laminar flow workstation intended to work with gametes and/or embryos at or near body temperature during in vitro fertilization (IVF)/assisted reproduction technology (ART) procedures. The workstation also provides humidified gas to maintain gametes and embryos in the working environment.

### Caution

- Federal law restricts this device to sale by or on the order of a licensed healthcare practitioner.
- Only to be used by a trained and qualified professional. The device is sold under exemption specified in 21 CFR 801 Subpart D.

# Multi-Zone ART Workstation with MIRI<sup>®</sup> Chambers

The Multi-Zone ART Workstation is now even better with its integrated MIRI<sup>®</sup> chambers to further secure your embryos while inside the workstation. The MIRI<sup>®</sup> incubator is popular for its top-notch features such as stable culture environment and faster parameter recovery.



## Multi-Zone Heating System

1 set point, 8 (7+1) independent zones with their own heating elements and sensors.



## MIRI<sup>®</sup> Chambers

Your specimens are more secure than ever with the integrated MIRI<sup>®</sup> chambers, known for its stable and precise temperature output.



## UV Kit (Optional)\*

Optional UV lamp for work zone decontamination. It also comes with polycarbonate front cover for UV shield and magnetic interlock for safety mechanism when cover is removed.

## Support Stand Options

To see available support stand configurations, please refer to page 19.

## Fit in the same MIRI<sup>®</sup> Heating Optimization Plates



Nunc™



Falcon®



Vitrolife



LifeGlobal®



BIRR



SparMED Oosafe®

## Accessories



### Support Stand:

- With leveling feet
- With Caster Wheels
- Telescopic stand with Caster Wheels



### UV Kit\*



### Pre-Filter



### 32mm Microscope pillar

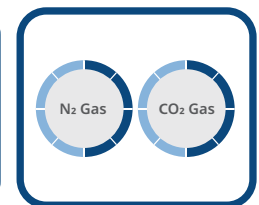

### Gas Mixer for MAW

\*Esco reserves the right to make periodic minor design changes without obligation to notify any person or entity of such change.

# Multi-Zone ART Workstation (Single Microscope) with MIRI<sup>®</sup> Chambers

MAW-4D\_-MC

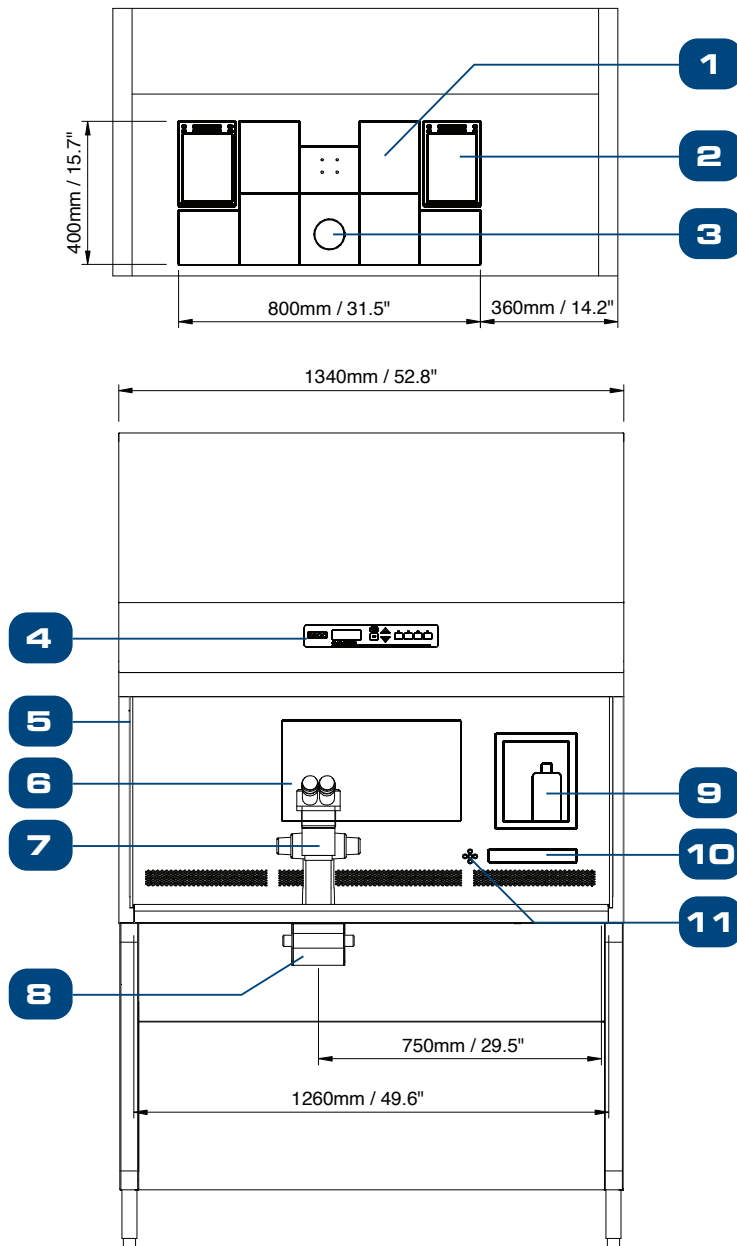

- Width: 4 Feet
- Microscope: Single
- Accommodates 1 user
- Basic Configuration with 2 MIRI<sup>®</sup> Chambers
- Ideal for small laboratories

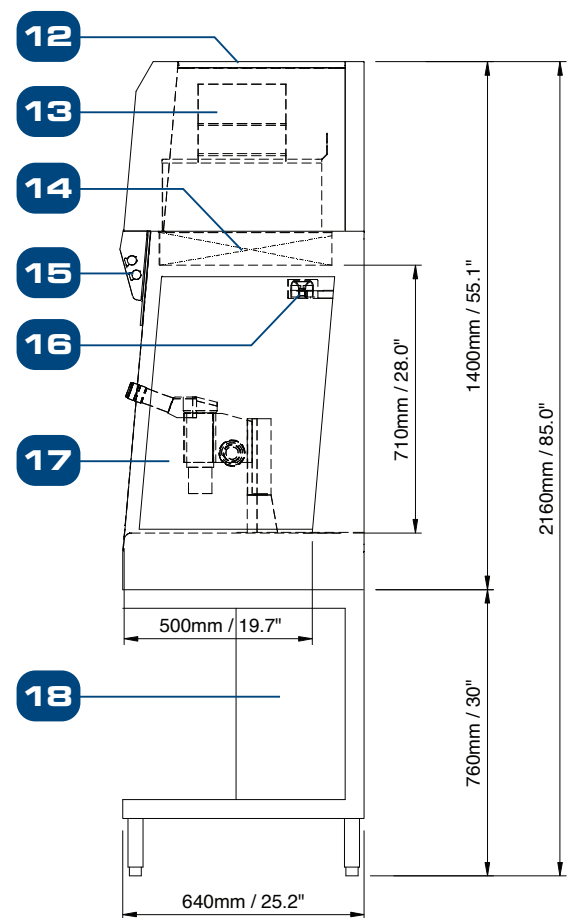

1. Multi-Zone Heated Table Top
2. MIRI<sup>®</sup> Chamber
3. Integrated Heated Glass Stage
4. Esco Sentinel<sup>™</sup> Gold Microprocessor Control System
5. Side Tempered Glass
6. Touchscreen Monitor (AIO PC)
7. Provision for Microscope (Microscope not Included)
8. Integrated Light Source, SC-1
9. Humidification System with Digital Flow Control of Pre-mixed Gas
10. LED Display
11. Control Panel for Heated Table Top and Humidification System
12. Pre-Filter
13. Blower
14. ULPA Filter
15. Fluorescent Light
16. Airflow Sensor
17. Side Tempered Glass
18. Support Stand (Model: SML-4B0)

# Multi-Zone ART Workstation (Single Microscope) with MIRI<sup>®</sup> Chambers

## MAW-6D\_-MONO-MC

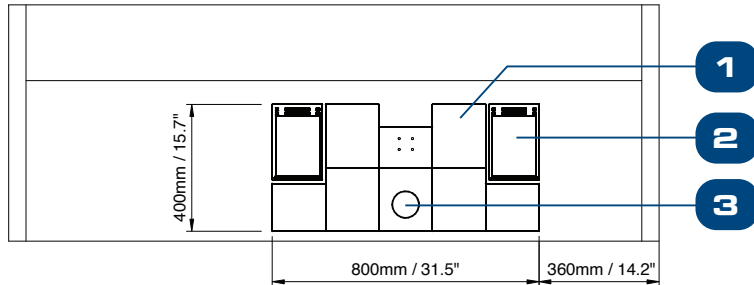

- Width: 6 Feet
- Microscope: Single
- Accomodates 1 user
- Basic Configuration with 2 MIRI<sup>®</sup> Chambers
- For users that require additional workspace

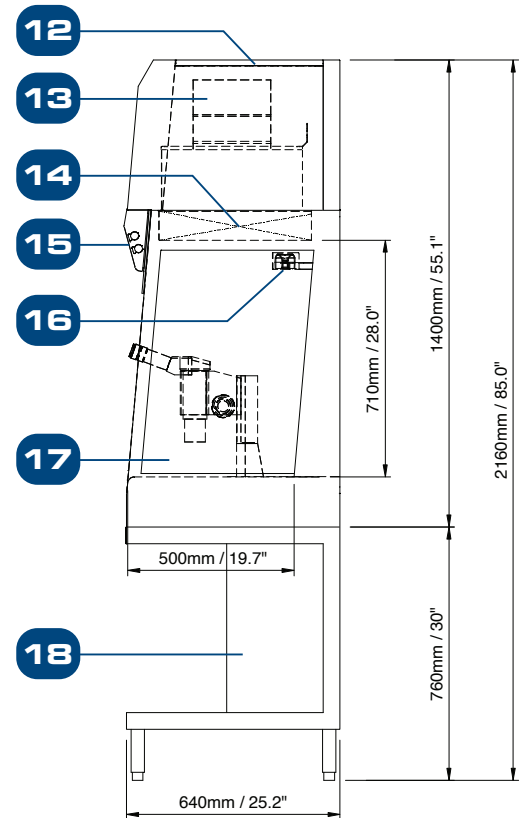
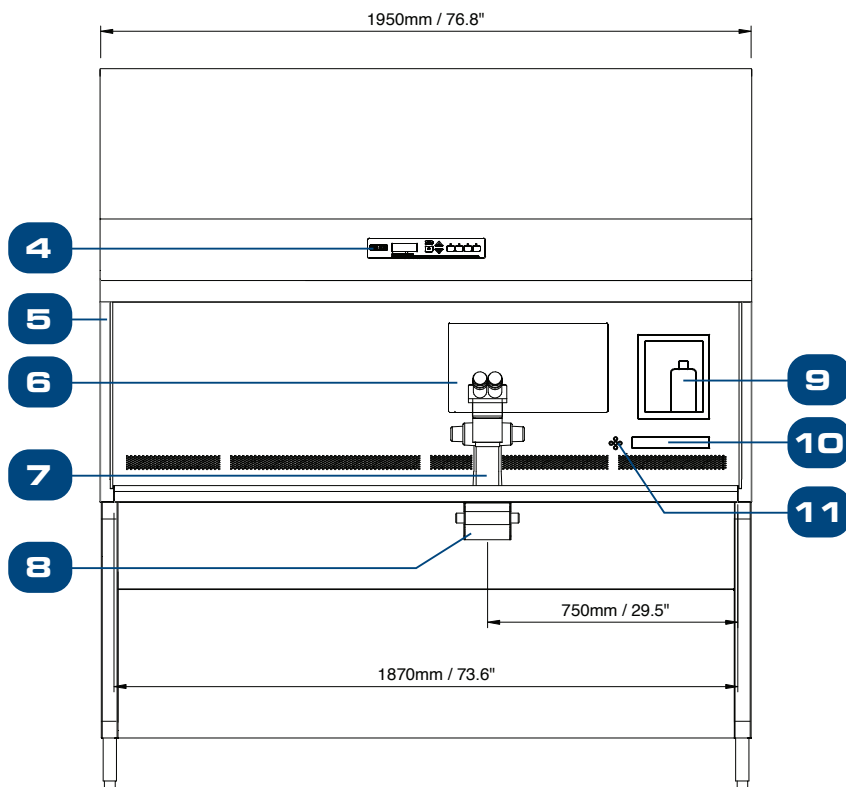

- |   |  |
|---|--|
| 1. Multi-Zone Heated Table Top                                      | 10. LED Display  |
| 2. MIRI <sup>®</sup> Chamber  | 11. Control Panel for Heated Table Top and Humidification System |
| 3. Integrated Heated Glass Stage                                    | 12. Pre-Filter   |
| 4. Esco Sentinel™ Gold Microprocessor Control System                | 13. Blower   |
| 5. Side Tempered Glass  | 14. ULPA Filter  |
| 6. Touchscreen Monitor (AIO PC)                                     | 15. Fluorescent Light  |
| 7. Provision for Microscope (Microscope not Included)               | 16. Airflow Sensor   |
| 8. Integrated Light Source, SC-1                                    | 17. Side Tempered Glass  |
| 9. Humidification System with Digital Flow Control of Pre-mixed Gas | 18. Support Stand (Model: SML-6B0)                               |

# Multi-Zone ART Workstation (Dual Microscope) with MIRI<sup>®</sup> Chambers

## MAW-6D\_-DUAL-MC

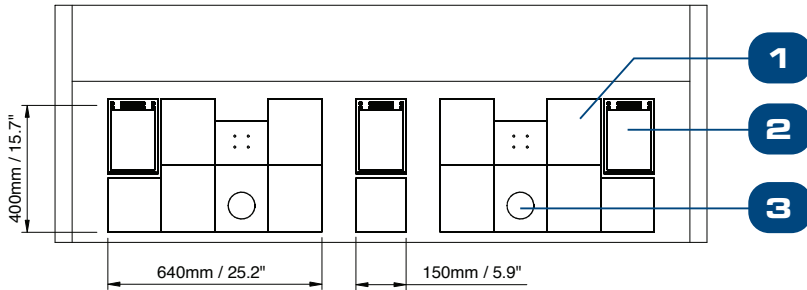

- Width: 6 Feet
- Microscope: Dual
- Accomodates 2 users
- For those who want to use all available area of the workspace

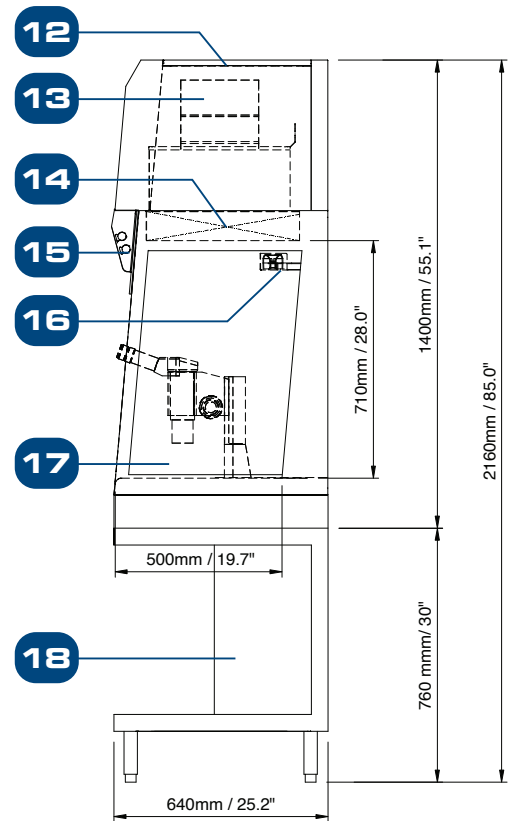
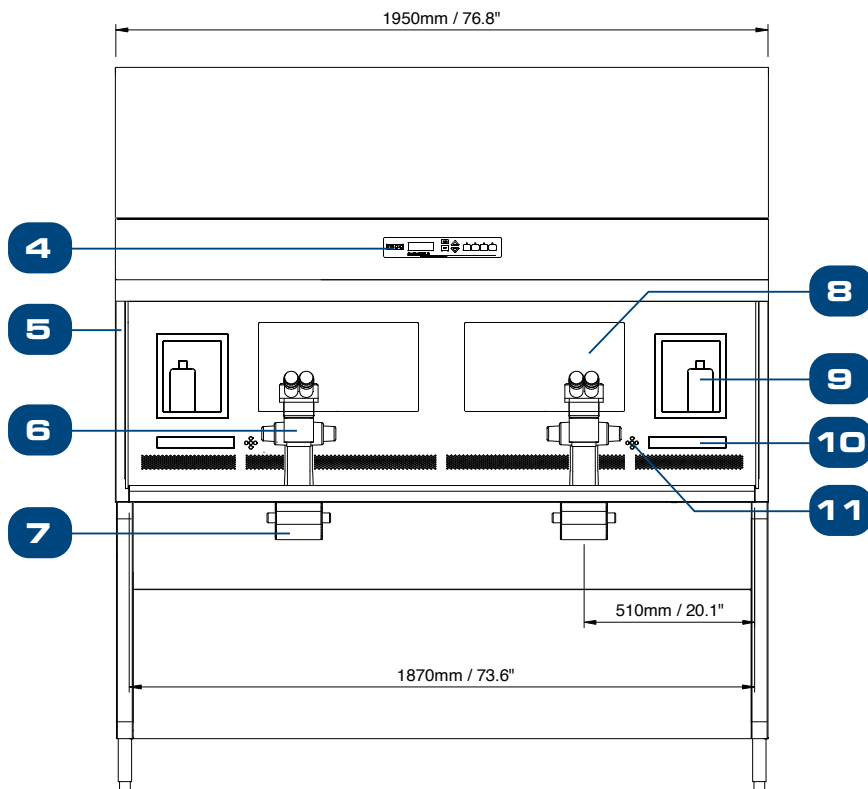

- |   |  |
|---|--|
| 1. Multi-Zone Heated Table Top                                      | 10. LED Display  |
| 2. MIRI <sup>®</sup> Chamber  | 11. Control Panel for Heated Table Top and Humidification System |
| 3. Integrated Heated Glass Stage                                    | 12. Pre-Filter   |
| 4. Esco Sentinel™ Gold Microprocessor Control System                | 13. Blower   |
| 5. Side Tempered Glass  | 14. ULPA Filter  |
| 6. Provision for Microscope (Microscope not Included)               | 15. Fluorescent Light  |
| 7. Integrated Light Source, SC-1                                    | 16. Airflow Sensor   |
| 8. Touchscreen Monitor (AIO PC)                                     | 17. Side Tempered Glass  |
| 9. Humidification System with Digital Flow Control of Pre-mixed Gas | 18. Support Stand (Model: SML-6B0)                               |

# Multi-Zone ART Workstation (Multi-Purpose) with MIRI<sup>®</sup> Chambers

MAW-6D\_-MP-MC

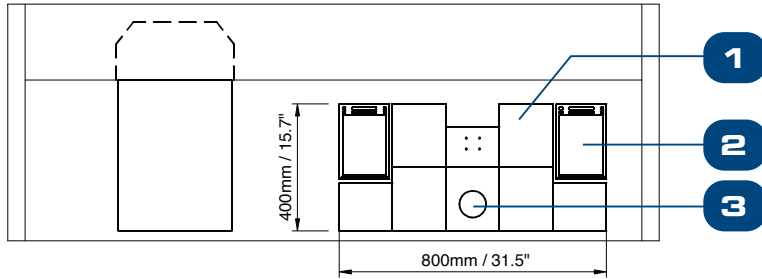

- Width: 6 Feet
- Microscope: Single
- Accomodates 1 user
- Basic Configuration with 2 MIRI<sup>®</sup> Chambers
- For users that require additional workspace

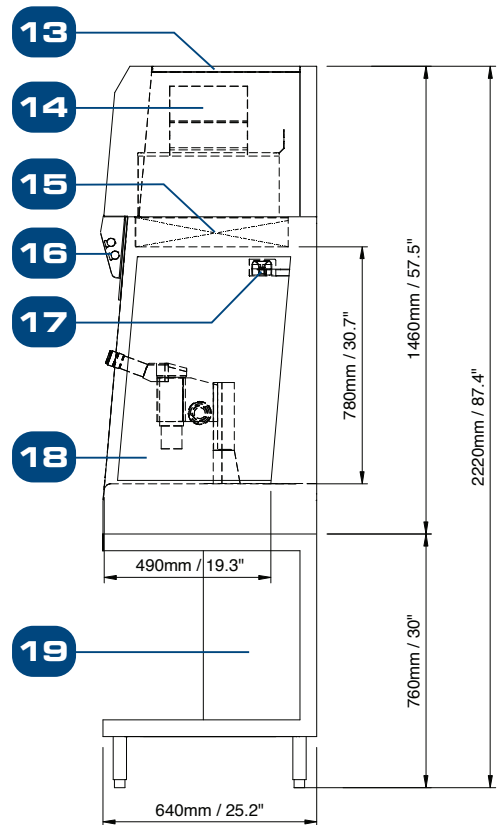
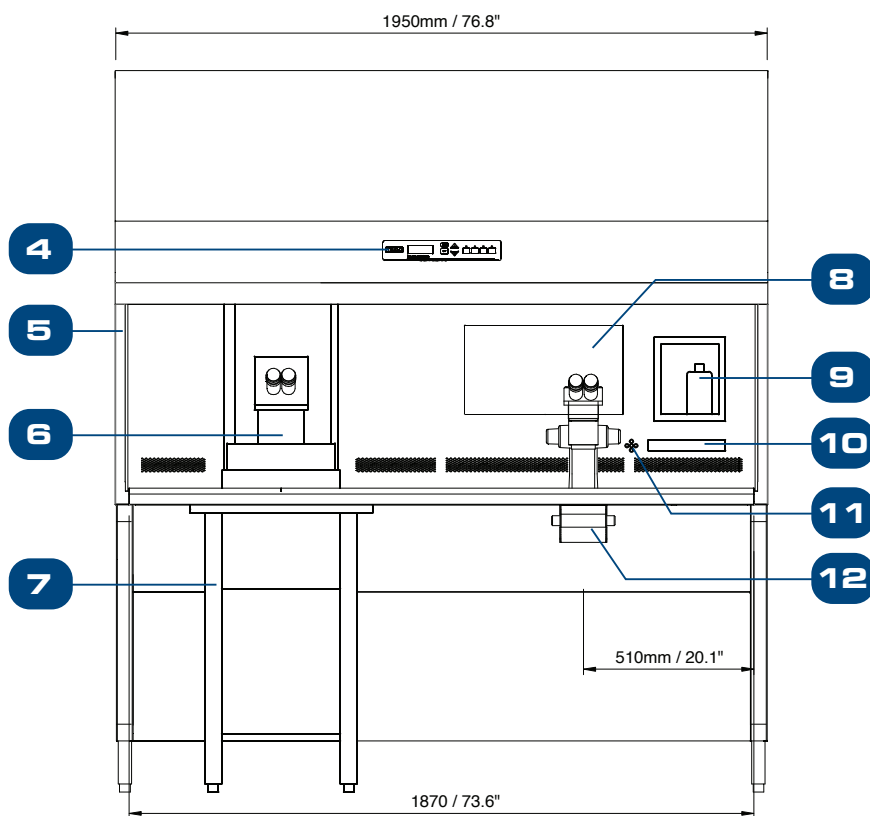

- |   |  |
|---|--|
| 1. Multi-Zone Heated Table Top (7+1 Zones)                          | 10. LED Display  |
| 2. MIRI <sup>®</sup> Chamber  | 11. Control Panel for Heated Table Top and Humidification System |
| 3. Integrated Heated Glass Stage                                    | 12. Integrated Light Source, SC-1                                |
| 4. Esco Sentinel <sup>™</sup> Gold Microprocessor Control System    | 13. Pre-Filter   |
| 5. Side Tempered Glass  | 14. Blower   |
| 6. Inverted Microscope (Not included)                               | 15. ULPA Filter  |
| 7. Anti-Vibration Table (AVT)                                       | 16. Fluorescent Light  |
| 8. Touchscreen Monitor (AIO PC)                                     | 17. Airflow Sensor   |
| 9. Humidification System with Digital Flow Control of Pre-mixed Gas | 18. Side Tempered Glass  |
|   | 19. Support Stand (Model: SML-6B0)                               |



# General Specifications

## Multi-Zone ART Workstation (MAW) with MIRI® Chambers

Model	MAW-4D_-MC	MAW-6D_-MONO-MC	MAW-6D_-DUAL-MC	MAW-6D_-MP-MC
Nominal Size	1.2 meter (4')	1.8 meter (6')	1.8 meter (6')	1.8 meter (6')
Internal Work area dimensions (W x D x H)*	1260 x 500 x 710 mm (49.6" x 19.7" x 28.0")	1870 x 500 x 710 mm (73.6" x 19.7" x 28.0")	1870 x 500 x 710 mm (73.6" x 19.7" x 28.0")	1870 x 490 x 780 mm (73.6" x 19.3" x 30.7")
External dimensions w/o support stand (W x D x H)	1340 x 640 x 1400 mm (52.8" x 25.2" x 55.1")	1950 x 640 x 1400 mm (76.8" x 25.2" x 55.1")	1950 x 640 x 1400 mm (76.8" x 25.2" x 55.1")	1950 x 647 x 1460 mm (76.8" x 25.4" x 57.5")
External Dimensions w/ "B" type support stand (W x D x H)	1340 x 640 x 2160 mm (52.8" x 25.2" x 85.0")	1340 x 640 x 2160 mm (52.8" x 25.2" x 85.0")	1950 x 640 x 2160 mm (76.8" x 25.2" x 85.0")	1950 x 647 x 2220 mm (76.8" x 25.4" x 87.4")
Cabinet Construction	Main Body	1.2 mm (0.05") 18 gauge electro-galvanized steel with white oven-baked epoxy-polyester powder-coated finish.		
	Work Zone	1.2 mm (0.05") 18 gauge stainless steel, grade 304		
	Side Walls	Tempered Glass (Optional: Polycarbonate sash for MAW with built-in UV light)		
	Sash			
Laminar Air Velocity	Average of 0.21m/s or 41 fpm (± 20%)			
Pre-Filter	Disposable, non-washable polyester fibre, 85% arrestance, EU3 rated			
ULPA Filter Efficiency	>99.999% for particle size between 0.1 to 0.3 microns per IEST-RP-CC001.3 / H14 per EN 1822			
Noise Level (as per IEST)	47 dBA	52 dBA		
Set of (7+1) Heating Zones	1	1	2	1
Number of MIRI® Chambers	2	2	3	2
Included Accessories	1 x water bottle for HS-1, including tubing 2 x sample carry tray	1 x water bottle for HS-1, including tubing 2 x sample carry tray	2 x water bottle for HS-1, including tubing 3 x sample carry tray	1 x water bottle for HS-1, including tubing 2 x sample carry tray
Microscope	Required, Not included (see microscope ordering information)			
	Position for 1 stereo microscope	Position for 1 stereo microscope	Position for 2 stereo microscopes	Position for 1 microscope and 1 inverted microscope
Support stand	Required, Not included (see support stand ordering information)			
Gas sample ports	1 IN / 1 OUT			
Operating altitude	Up to 2000 meters (6560 feet or 89kPa – 106kPa)			

## Designed With Excellence In Mind

*Esco Multi-Zone ART Workstation is the perfect choice for your laboratory, thanks to its advanced features and cutting-edge technology.*



# Ordering Information

Item Code	Model Code	Description
<b>Esco Multi-Zone ART Workstation Basic Configuration and Multi-Purpose</b>		
2070177	MAW-3D8	Esco Multi-Zone ART Workstation, 3ft (0.91m), 230V 50/60Hz
2070017	MAW-4D8	Esco Multi-Zone ART Workstation, 4ft (1.2m), 230V 50/60Hz
2070025	MAW-4D9	Esco Multi-Zone ART Workstation, 4ft (1.2m), 115V 50/60Hz
2070018	MAW-6D8-MONO	Esco Multi-Zone ART Workstation, 6ft (1.8m), 230V 50/60Hz
2070026	MAW-6D9-MONO	Esco Multi-Zone ART Workstation, 6ft (1.8m), 115V 50/60Hz
2070050	MAW-6D8-DUAL	Esco Multi-Zone ART Workstation, Double Heated Zone, 6ft (1.8m), 230V 50/60Hz
2070039	MAW-6D9-DUAL	Esco Multi-Zone ART Workstation, Double Heated Zone, 6ft (1.8m), 115V 50/60Hz
2070036	MAW-6D8-MP	Esco Multi-Zone ART Workstation, Multi-Purpose, 6ft (1.8m), 230V 50/60Hz
2070038	MAW-6D9-MP	Esco Multi-Zone ART Workstation, Multi-Purpose, 6ft (1.8m), 115V 50/60Hz
<b>Esco ART Workstation with MIRI® Chambers</b>		
2070068	MAW-4D8-MC	Esco Multi-Zone ART Workstation, MIRI® Chambers, 4ft (1.2m), 230V 50/60Hz
2070070	MAW-4D9-MC	Esco Multi-Zone ART Workstation, MIRI® Chambers, 4ft (1.2m), 115V 50/60Hz
2070069	MAW-6D8-MONO-MC	Esco Multi-Zone ART Workstation, MIRI® Chambers, 6ft (1.8m), 230V 50/60Hz
2070071	MAW-6D9-MONO-MC	Esco Multi-Zone ART Workstation, MIRI® Chambers, 6ft (1.8m), 115V 50/60Hz
2070075	MAW-6D8-DUAL-MC	Esco Multi-Zone ART Workstation, Double Heated Zone, MIRI® Chambers, 6ft (1.8m), 230V 50/60Hz
2070074	MAW-6D9-DUAL-MC	Esco Multi-Zone ART Workstation, Double Heated Zone, MIRI® Chambers, 6ft (1.8m), 115V 50/60Hz
2070072	MAW-6D8-MP-MC	Esco Multi-Zone ART Workstation, Multi-Purpose, MIRI® Chambers, 6ft (1.8m), 230V 50/60Hz
2070073	MAW-6D9-MP-MC	Esco Multi-Zone ART Workstation, Multi-Purpose, MIRI® Chambers, 6ft (1.8m), 115V 50/60Hz
<b>ART Workstation with MIRI® Chambers and Trigas Mixer</b>		
2070187	MAW-4D8-MC-G	Esco Multi-Zone ART Workstation, MIRI® Chambers, Gas Mixer, 4ft (1.2m), 230V 50/60Hz
2070188	MAW-4D9-MC-G	Esco Multi-Zone ART Workstation, MIRI® Chambers, Gas Mixer, 4ft (1.2m), 115V 50/60Hz
2070189	MAW-6D8-MONO-MC-G	Esco Multi-Zone ART Workstation, MIRI® Chambers, Gas Mixer, 6ft (1.8m), 230V 50/60Hz
2070190	MAW-6D9-MONO-MC-G	Esco Multi-Zone ART Workstation, MIRI® Chambers, Gas Mixer, 6ft (1.8m), 115V 50/60Hz
2070191	MAW-6D8-DUAL-MC-G	Esco Multi-Zone ART Workstation, Double Heated Zone, MIRI® Chambers, Gas Mixer, 6ft (1.8m), 230V 50/60Hz
2070192	MAW-6D9-DUAL-MC-G	Esco Multi-Zone ART Workstation, Double Heated Zone, MIRI® Chambers, Gas Mixer, 6ft (1.8m), 115V 50/60Hz
2070193	MAW-6D8-MP-MC-G	Esco Multi-Zone ART Workstation, Multi-Purpose, MIRI® Chambers, Gas Mixer, 6ft (1.8m), 230V 50/60Hz
2070194	MAW-6D9-MP-MC-G	Esco Multi-Zone ART Workstation, Multi-Purpose, MIRI® Chambers, Gas Mixer, 6ft (1.8m), 115V 50/60Hz

## Recommended List of Microscopes and the Base Stand Types

Inverted Microscope for MP Series Workstation Only
Olympus IX83P1ZF: One-Deck
Olympus IX73P1F: One-Deck (Customization on workstation needed)
Olympus IX73P2F: Two-Decks
Olympus IX53P1F: One-Deck (Customization on workstation needed)
Nikon Ti-U
Nikon Ti-S
Nikon Ti-E
Zeiss Axio Vert.A1
Zeiss Axio Vert.A1 FL
Zeiss Axio vert.A1 FL-LED





Stereomicroscope Provisions	
Microscope types	Base stand
Esco Stereomicroscope MS-1	Standard
Nikon SMZ series	C-PS / C-PS160 / C-DSS
Olympus SZX series	SZX-ST / SZX2-ST/SZ2-ST
Carl Zeiss	Stand N / V8 with T-pillar
Leica	S8AP0

## Accessories

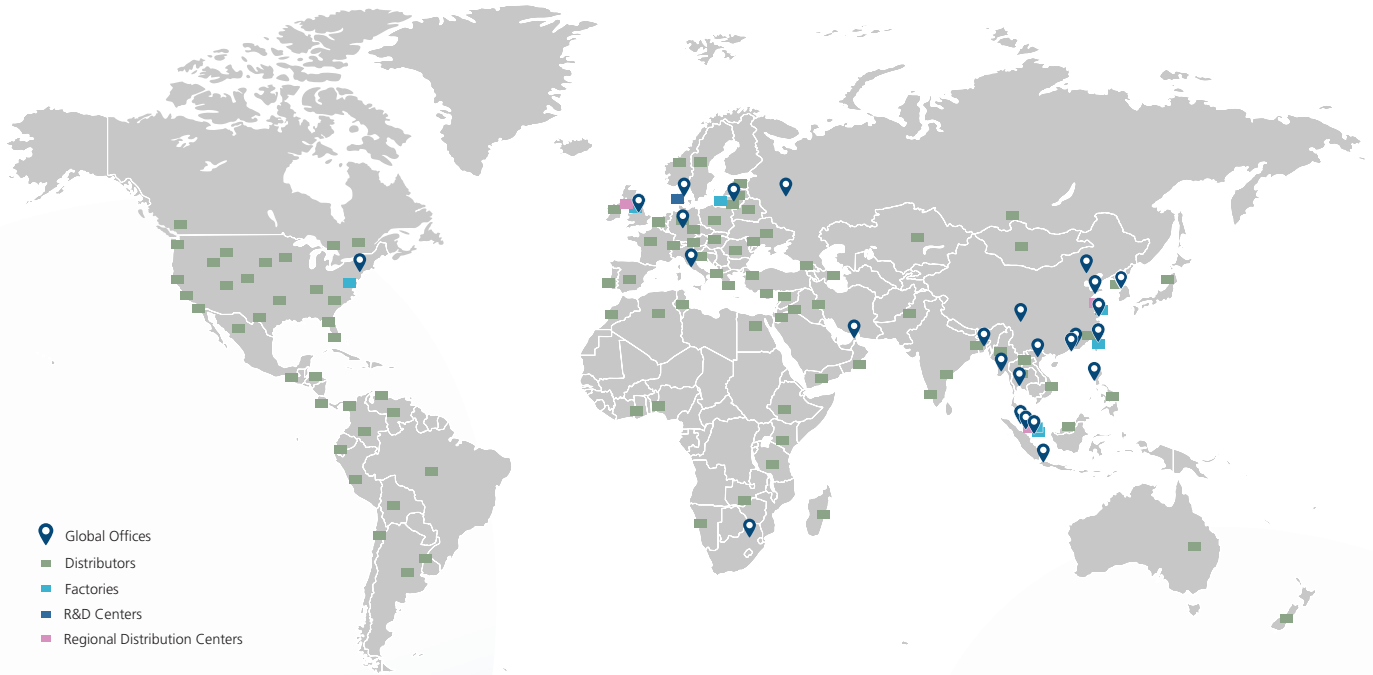
Item Code	Model Code	Description
5131413	SMC-3A0	Support Stand with Caster Wheels (Height 24") for 3ft Cabinets
5131414	SMC-3B0	Support Stand with Caster Wheels (Height 30") for 3ft Cabinets
5131415	SML-3A0	Support Stand with Leveling Feet (Height 24") for 3ft Cabinets
5131416	SML-3B0	Support Stand with Leveling Feet (Height 30") for 3ft Cabinets
5131417	SMTC-3A0	Support Stand Telescopic 3Ft MAW, adjustable height
5131387	SMTC-4A0	Support Stand Telescopic 4Ft MAW, adjustable height
5131388	SMTC-6A0	Support Stand Telescopic 6Ft MAW, adjustable height
5171026	FC-MAW3-8	UV+Front Cover with magnetic interlock and bracket, MAW-3FT, 230V 50/60 Hz 5170799
5130179	SMC-4A0	Support Stand with Caster Wheels (Height 24") for 4ft Cabinets
5130180	SMC-6A0	Support Stand with Caster Wheels (Height 24") for 6ft Cabinets
5130181	SML-4A0	Support Stand with Leveling Feet (Height 24") for 4ft Cabinets
5130182	SML-6A0	Support Stand with Leveling Feet (Height 24") for 6ft Cabinets
5130183	SMC-4B0	Support Stand with Caster Wheels (Height 30") for 4ft Cabinets
5130184	SMC-6B0	Support Stand with Caster Wheels (Height 30") for 6ft Cabinets
5130185	SML-4B0	Support Stand with Leveling Feet (Height 30") for 4ft Cabinets
5130186	SML-6B0	Support Stand with Leveling Feet (Height 30") for 6ft Cabinets
5131255	SMC-4A8-M	Motorized Support Stand for 4ft Cabinet, Caster Wheels, 230VAC 50/60Hz Adjustable Height: 753mm to 1053mm
5131266	SMC-4A9-M	Motorized Support Stand for 4ft Cabinet, Caster Wheels, 115VAC 50/60Hz Adjustable Height: 753mm to 1053mm
5131264	SMC-6A8-M	Motorized Support Stand for 6ft Cabinet, Caster Wheels, 230VAC 50/60Hz Adjustable Height: 753mm to 1053mm
5131267	SMC-6A9-M	Motorized Support Stand for 6ft Cabinet, Caster Wheels, 115VAC 50/60Hz Adjustable Height: 753mm to 1053mm
1320075	MAW-WB1	Tube Warming Block
1320071	MAW-MS1	Stereomicroscope, Total magnification: 6.7X - 45X
5080185	MAW-CPF	Carbon Pre-Filter (568 x 440 x 30 mm). Factory-Installed.Please order 2 units for 4 feet MAW and 3 units for 6 feet MAW
5090001	PF-MAW-2	Pre-Filter, 500 x 400 Polyester Media, PF-2
5090009	PF-MAW-12	Pre-Filter, 565 x 500, Polyester Media , PF-12
5170798	FC-MAW4-8	UV+Front Cover with magnetic interlock and bracket, MAW-4FT, 230V 50/60 Hz
5170799	FC-MAW6-8	UV+Front Cover with magnetic interlock and bracket, MAW-6FT, 230V 50/60 Hz
5170853	FC-MAW4-9	UV+Front Cover with magnetic interlock and bracket, MAW-4FT, 115V 50/60 Hz
5170854	FC-MAW6-9	UV+Front Cover with magnetic interlock and bracket, MAW-6FT, 115V 50/60 Hz
5170882	MAW-G	CO <sub>2</sub> /N <sub>2</sub> Gas Mixer (CO <sub>2</sub> / O <sub>2</sub> Gas mixing control in MAW). One (1) mixer needed for each MAW
5074858	MAW-PF	MAW-4/6 Pre-filter, 565 x 440, with plate for MAW-4/6 Standard

# ESCO LIFESCIENCES GROUP



-  Global Offices
-  Distributors
-  Factories
-  R&D Centers
-  Regional Distribution Centers

## Esco Medical Products:

MIRI® Multiroom Incubator  
 MIRI® Humidity Multiroom Incubator  
 MIRI® II-12 Multiroom Incubator  
 Mini MIRI® Dry Multiroom Incubator  
 Mini MIRI® Humidity Multiroom Incubator

MIRI® TL6 Time-Lapse Incubator  
 MIRI® TL12 Time-Lapse Incubator  
 Multi-Zone ART Workstation  
 MIRI® Laminar Flow Cabinet  
 MIRI® Evidence RFID Witnessing & Traceability System

CelCulture® CO<sub>2</sub> Incubator  
 MIRI® GA (Gas and Temperature Validation Unit)  
 MIRI® AVT  
 CultureCoin®

*Infertility is a problem that has a significant social, psychological, and economic impact on afflicted individuals and couples. It is a global concern that knows no race or creed. It has been estimated that 1 in 6 couples struggle with infertility at least once in their lifetime.*

*Esco Medical is one of the divisions of the Esco Lifesciences Group. We provide innovative technological solutions for fertility clinics and laboratories. We aim to become the leading manufacturer of high-quality equipment such as long-term embryo incubators, ART workstations, anti-vibration tables, and time-lapse incubators.*

*Our products are designed with the Silent Embryo Hypothesis as a guiding principle. The Silent Embryo Hypothesis states that the less disturbed an embryo can remain, the better its developmental potential will be. Most of our products are designed in Denmark and made in the EU. Our primary focus is to increase pregnancy success rates and patient satisfaction.*



**Esco Medical, Aps**  
 Kringelled 10, 8250 Egaa, Denmark  
 medical@escolifesciences.com  
[www.esco-medical.com](http://www.esco-medical.com)

**Esco Micro, Pte. Ltd. (Headquarters)**  
 19 Changi South Street 1, Singapore 486 779  
 Tel +65 6542 0833

**Esco Global Offices:** Bangladesh | China | Denmark | Germany | Hong Kong | Indonesia | Lithuania | Malaysia | Myanmar | Philippines | Russia | Singapore | South Africa | South Korea | Taiwan | Thailand | UAE | UK | USA | Vietnam